

CONTROL UNITS FOR IRRIGATION MOTOR PUMPS AND PUMP WATER PRESSURE CONTROL

TYPE CIM-131

INSTRUCTION AND USER MANUAL



- Operates the engine accelerator to keep the pressure of the system constant. (accelerator with 2 wires connected to the control unit)
- Controls the flow of water in the pipe.
- Electronic pressure switch to control the pump water pressure.
- Digital pump water pressure gauge.
- Clock for programming the starting and stopping of the motor pump.
- Delayed acceleration after starting.
- Delayed deceleration before stopping.
- Assembly also on the machine and in the open air.
- CANBus SAE J1939 connection.
- Frost protection.
- Pressure boost function.

MADE TO:

PROTECT

motor pump sets by stopping them in the event of:

- low oil pressure
 - over-temperature
 - belt breakage
 - low coolant level
 - low pump water pressure
 - pump water overpressure
 - overspeed
 - A1
 - A2
- } available

DISPLAY

on the panel the functions of:

- hour-meter
- oil pressure gauge
- water or oil thermometer
- tachometer
- pump water pressure gauge
- timer
- fuel level gauge
- battery voltmeter
- pump protection exclusion
- battery and oil lights
- protections intervention
- emergency stop

PARMA



ELCOS®

ITALY

Tel. +39 0521/772021 Fax +39 0521/270218
E-mail: info@elcos.it - HTTP://www.elcos.it

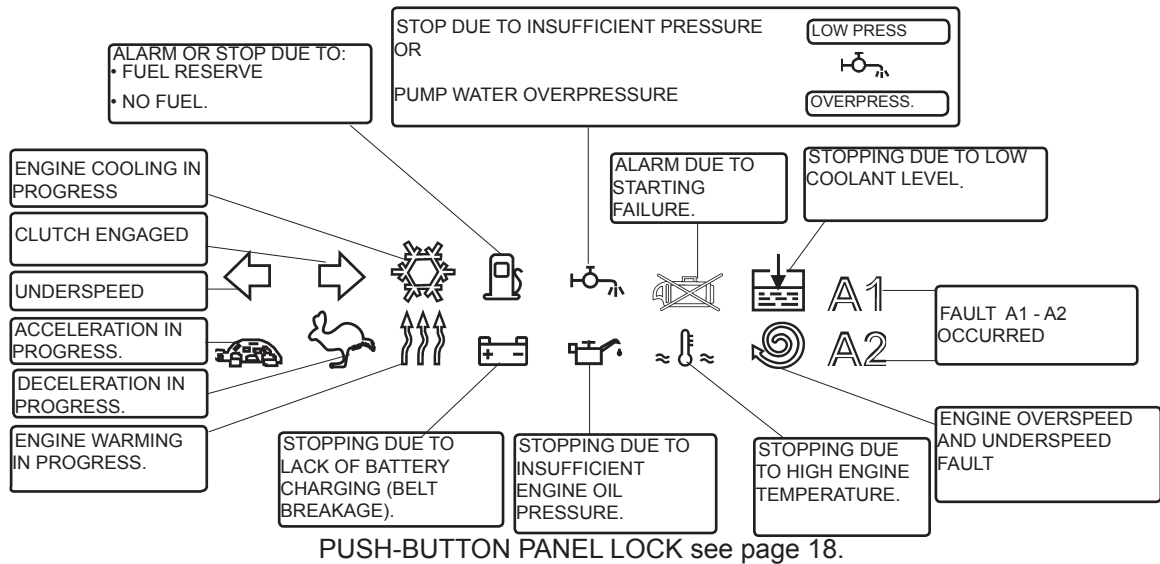

SWITCHING OFF OF PUMP PROTECTION DEVICES



Button switches off the pump protection devices:

- failure to prime main pump
- failure to fill pipes
- insufficient pump water pressure
- pump water overpressure
- abnormal acceleration
- adjustment error
- switching off is obtained by holding it down for at least 3 consecutive seconds; the function is indicated by the two intermittent indicators.
- this switching off is deleted by pressing the button again.

CONTENTS

Brief instructions and contents	page	2-3
Working pressure control-Pump protection-Failure to fill pipes.	"	4
Operation: Functions selection-Glow plugs preheating-Starting with call-Starting with start button-Starting-Starting failure-Detection of running engine-Automatic pump priming-Pump priming failure.	"	5
Operation: Clutch-Engine warming-Engine cooling-Stop-Emergency stop-Stop with the Stop and Off-Reset buttons-Stopping failure-Buzzer.	"	6
Operation: Timer-Resetting of the set time-Oil and battery warning lights-End of work-Instruments-CAN Bus messages and instruments-Anomaly messages-CAN Bus instruments- Cumulative alarms	"	7
Engine and pump protection devices	"	8-9
Wiring diagram	"	10-11
Automatic pump priming connection	"	12
Notices	"	13
User programming	"	14
Dimensions - Technical data	"	15
Ordering data - Accessories supplied - Conformity declaration	"	16

WORKING PRESSURE CONTROL



Select the **MANUAL** operating mode, start the motor pump with button **START**.

Factory Setting

The motor pump starts up if the motor pump is primed.

Set the required pressure with buttons after 10 seconds **BAR STORED** is displayed.

Wait until the pipes are filled and the pressure has stabilized at the chosen value. After finishing setting, **SELECT OPERATING MODE AUT**, the pressure of the system will remain set at the chosen pressure.

The chosen pressure value can be corrected with the system under pressure, by pressing buttons The working pressure setting is deleted, when the engine is stopped by selecting operating mode **OFF/RESET**.



SEQUENCE OF OPERATIONS

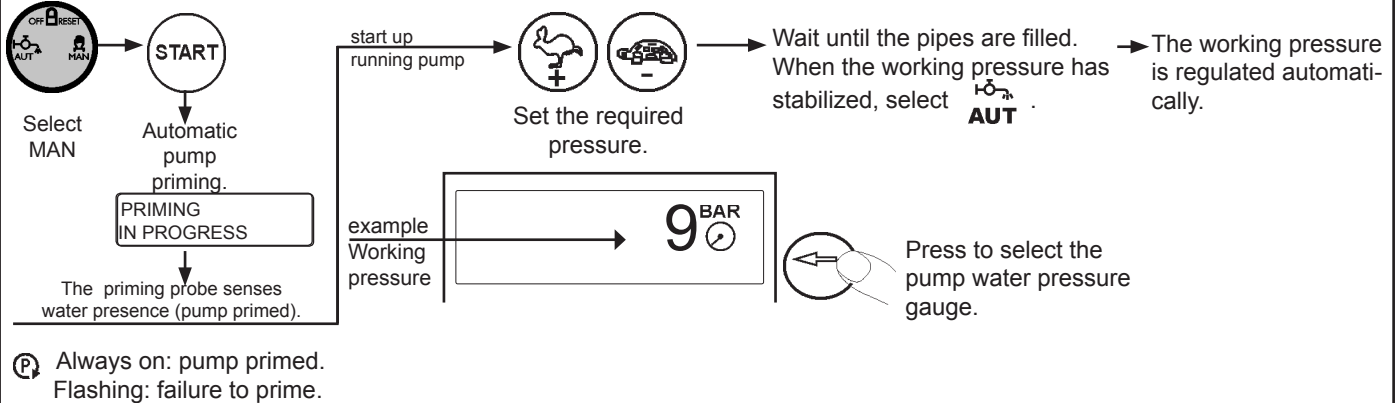

PUMP PROTECTION

NO ADJUSTING IS REQUIRED.

The pump protection is enabled when warning lights **PUMP PROTECTION ACTIVE** and **water pressure normal** come on after the water pressure has remained stable for 2 consecutive minutes, in any case 10 minutes after the engine started.

Intervention of the protection (5 seconds after the pressure goes up or down by **two bars**) stops the engine and is shown on the display: .

However it is possible to change the **two bars** of pressure

lowering (subpressure), by pressing button

This change is deleted, when the engine is stopped, by selecting the **OFF/RESET** operating mode.

OVERPRESSURE remains set to two bars, this value is added to the working pressure (for example, working pressure 9 bars overpressure 11 bars)

WORKING PRESSURE

Press to set the sub-pressure value (PRESSURE SWITCH)

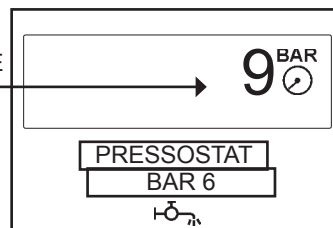

Press to select the pump water pressure gauge

FAILURE TO FILL PIPES FAULT

The acceleration starts with the engine running, with pump primed.

The motor pump reaches the redefined **WORKING PRESSURE** (see **BAR STORED**) within the **TIME OF FAILURE TO FILL PIPES**, set to 120 seconds. If air is present in the pipes, the acceleration will be alternated with pauses (of 15 seconds), if the pressure remains steady for 5 seconds. This situation will be repeated several times until the **WORKING PRESSURE** is reached. If the pressure is not reached within the **FAILURE TO FILL PIPES** time (120 sec.), **FAILURE TO FILL PIPES** is displayed on the display and the engine stops.

ABNORMAL ACCELERATION

(Pipe leakage controlled within the limits of the system).

As a result of a leakage, the engine tends to increase the revolutions to bring it back to **WORKING PRESSURE**. If the revolutions increase by 10% for a time longer than 120 seconds, **ABNORMAL ACCELERATION** is displayed on the display and the engine stops.

OPERATION



To activate the control unit press the button.

FUNCTIONS SELECTION



The function selected with the key is shown by the associated warning light.



- AUT Automatic pressure control.
- OFF The engine cannot be started and if running it is stopped.
- MAN Operation without automatic pressure control.

GLOW PLUGS PREHEATING ACTIVATED BEFORE STARTING (GLOW PLUG IS SHOWN ON THE DISPLAY)

The duration of the preheating action can be set, the preheating action ceases before the beginning of the starting process. The preheating control is disabled at the factory since it has been programmed to zero seconds.

THE STARTING OF THE MOTOR PUMP CAN BE OBTAINED IN THREE WAYS:

- CALL
- TIMER

The starting procedures are similar to each other.

- KEY

Factory Setting

The motor pump starts up if the motor pump is primed.

STARTING WITH CALL

When the call contact closes and the DELAY AFTER CALL CLOSED has elapsed, the control unit controls the glow plugs (if preset) and then the starting. If preset, the motor pump stays on idle for the whole ENGINE WARMING time, when this time has elapsed the motor pump reaches and maintains the preset working pressure. When the call contact opens once the STOP DELAY after CALL OPENING has elapsed, if preset the motor pump slowly decelerates, when the motor pump is on idle the ENGINE COOLING time starts.

When this time has elapsed the motor pump stops. During its operation the motor pump is protected from the faults controlled by the probes connected to the control unit.

STARTING WITH START BUTTON

To start, a pulse on the button is sufficient.

This takes place on closing of the CALL contact, or with Timer. Before beginning the starting process, a buzzer is activated for 8 seconds, and after a 3-second pause the starting process begins. To facilitate startup, a special circuit emits a series of four, 5-second pulses, with a 5-second delay between each pulse.

STARTING FAILURE

Blocks the startup cycle if the pump has not started up after the fourth pulse.

DETECTION OF ENGINE RUNNING

It is obtained with measurement of the voltage and frequency of the battery charging alternator. Disables the starter motor.

AUTOMATIC PUMP PRIMING (ALWAYS ON)

The priming pump starts; when the priming probe senses the presence of water, the pump stops and after 15 seconds the engine starting begins.

PUMP PRIMING FAILURE (FLASHING)

The priming probe does not sense the presence of water and a time higher than 240 seconds has elapsed.

OPERATION

CLUTCH

This is engaged on reaching a certain engine speed. This clutch disengages when the engine speed drops below the set value.

ENGINE WARMING (factory-excluded)

After closing of the call contact or TIMER or SMS pump priming takes place, the engine stays on idle for the time necessary to allow warming of the engine. After this time has elapsed the engine slowly reaches the working pressure. During heating the protection devices are active.

ENGINE COOLING

On opening of the call contact or TIMER the engine slowly decelerates. When the engine is on idle the COOLING TIME starts, and after this time has elapsed the engine stops.

Stopping is obtained:

STOP

- Through intervention of the protection devices.
- Through end of work of the clock and of the timer .
- By pressing the emergency button (to be fitted externally).
- On opening of the call contact.
- At end of work through intervention of the underspeed or the flow switch.



- On pressing buttons , the engine stops after slow deceleration.

Stopping can be obtained in two ways:

- With electromagnet de-energized with engine running and energized with it stopped, remaining in this condition for 15 sec. after detection of engine stopped.
On pressing button  the stopping electromagnet stays energized for 60 seconds.
- With electromagnet or electro-valve activated while the engine is running and deactivated when stopped. This condition is maintained even when the engine is stationary.

EMERGENCY STOP

This can be obtained in any operating condition, by installing one or more (latching) buttons. This is indicated by the optical indicator .

STOPPING WITH THE STOP AND OFF-RESET BUTTONS



- On pressing briefly, the led stays off, the motor pump stops if the call or the timer are not active.
- On pressing (3 seconds) until the LED flashes, the motor pump stops and starting by call and by timer are disabled, with the engine stopped the warning light remains flashing. The deletion of this switching off occurs on pressing the stop button (3 seconds) until the flashing warning light goes out.



Press until switching on of .

The engine cannot be started in any way and if it is running it is stopped. Reactivates the protection devices and all the locked functions.

STOPPING FAILURE

This intervenes if the running engine signal is detected 60 seconds after the stop command.

 will be read on the display.

BUZZER

The control unit has its own buzzer. Before starting automatically the motor pump activates the buzzer intermittently for 8 seconds, followed by a pause of 3 seconds (this function can be switched off). This buzzer also operates for the intervention of the protection devices listed on page 8-9. It is possible to place a buzzer externally to be connected to the relevant output.

OPERATION

TIMER

Always enabled, allows if necessary the motor pump to be operated for a settable time (maximum 96 hours), at the end of which it is stopped and on the display the end of work time indicator  comes on.

The work time is set by pressing the push-button  ( lights up) until the desired value appears on the DISPLAY .

On releasing the push-button, the timer automatically starts working, continuously displaying the remaining work time.

CANCELLING THE SET TIME

To zeroing the set time, keep the push-button  pressed until it reaches zero.

OIL AND BATTERY WARNING LIGHTS



Switched on with the automatic or manual function these switch off with the engine running with oil pressure and battery recharging system normal. Control unit in Stand by, warning light pulses .

END OF WORK



(Flow stopped)

When the engine revolutions fall by 10% and the WORKING PRESSURE stays constant for 120 seconds END OF WORK is displayed on the display and the engine stops.

If there is not this condition, a flow switch must be installed (End of work with flow switch see on page 9).

INSTRUMENTS

The control unit incorporates seven instruments that can be selected in sequence by pressing button .

 HOUR-METER - total hours of operation with the engine running the signal  pulsates, to indicate the correct functioning of the HOUR-METER).

 PRESSURE GAUGE - Engine oil pressure

 THERMOMETER - Engine oil and water temperature

 TACHOMETER - Speed of motor pump

 PRESSURE GAUGE - Engine water pressure

 INDICATOR - Fuel level percentage

 VOLTMETER - Battery voltage

TRANSMITTERS MOUNTED ON THE ENGINE
ON REQUEST

MESSAGES AND CAN Bus INSTRUMENTS

Sent (SAE J1939 protocol Bus) from the engine equipped with control unit for electronic control of the injection system.

ANOMALY MESSAGES





The anomaly messages managed by the injection control unit are indicated on the display CAN Bus.

Problems of connection CAN Bus to the CAN Bus.

CAN Bus INSTRUMENTS









TACHOMETER - OIL PRESSURE GAUGE - THERMOMETER









CUMULATIVE ALAR

-  LED (red) STEADY LIGHT: anomaly managed by the injection control unit **will cause the engine to stop.**
 -  LED (red) FLASHING LIGHT: anomaly managed by the control unit CIM-131 **will cause the engine to stop.**
 -  LED (yellow) STEADY LIGHT: anomaly managed by the injection control unit **will NOT cause the engine to stop.**
 -  LED (yellow) FLASHING LIGHT: anomaly managed by the control unit CIM-131 **will NOT cause the engine to stop**, or indicates a preventive maintenance operation.
- LED OFF ALL OK.**

ENGINE AND PUMP PROTECTION DEVICES

The ENGINE PROTECTION DEVICES are enabled when indicator  comes on (10 seconds after detection of engine running ). The PUMP PROTECTION is enabled when  comes on after 2 consecutive minutes of sufficient water pressure, indicated by NORMAL PRESSURE indicator  and in any case 10 minutes after the pump started. Intervention due to a fault enables the GENERAL ALARM.

DESCRIP- TION OF FAULTS OR FUNCTIONS	INDICATION ON THE FRONT PANEL	MOTOR PUMP PROBE	INSTANT OF ACTIVATION (seconds)	INTERVEN- TION DELAY (seconds)	PRO- GRAMMED THRESHOLD (FACTORY SETTING)	STORES THE FUNCTION	DECELE- RATION	ENGINE COOLING	STOP	INTERVENTION OCCURS WHEN:
BATTERY UNDER- VOLTAGE	BATTERY  UNDER-VOL- TAGE	BATTERY	Always active	2	11 (12V) 22 (24V)	NOT	=	NOT	DOES NOT STOP	Battery voltage remains lower than the program- med threshold for the whole of the intervention delay time.
BATTERY OVER- VOLTAGE	BATTERY OVER- VOLTAGE	BATTERY	Always active	5	16 (12V) 32 (24V)	YES	SLOW	NOT	DOES NOT STOP	Battery voltage exceeds the programmed threshold for the whole of the intervention time.
OVER- HEATING DETECTED BY THERMOSTA- TIC SWITCH	OVER- HEATING 	THERMOSTA- TIC SWITCH	With running engine	2	=	YES	SLOW	YES	WITH STOP	The temperature detected by the transmitter exceeds the set threshold.
FUEL RESERVE	FUEL RESERVE  Flashing	FUEL FLOAT TERMINAL T	Always active	5	10%	NOT	=	NOT	DOES NOT STOP	
NO FUEL	NO FUEL  Always on	FUEL FLOAT TERMINAL W	Always active	5	1%	YES	SLOW	YES	WITH STOP	The fuel level remains lower than the threshold for the whole of the intervention delay time.
LOW OIL PRESSURE	LOW OIL PRESSURE 	OIL PRESS- URE SWITCH	10 after detec- tion of running engine	2	=	YES	QUICK	NOT	WITH STOP	The pressure is lower than the threshold set by the pressure switch.
STOPPING FAILURE	STOPPING FAILURE	ELECTRO- VALVE OR ELECTRO- MAGNET	After the stop command	60	=	YES	=	NOT	DOES NOT STOP	The engine running signal is detected after the stop command and the intervention delay time has elapsed.
LOW RADIATOR FLUID LEVEL	LOW RADIATOR FLUID LEVEL 	LEVEL PROBE	Always active	5	=	YES	SLOW	NOT	WITH STOP	The coolant falls below the electrode and the inter- vention delay has elapsed.
CHARGING ALTERNATOR FAULT (BELT BREAKAGE)	CHARGING ALTERNATOR FAULT 	ALTERNATOR	10 after detec- tion of running engine	5	=	YES	SLOW	NOT	WITH STOP	Alternator does not recharge the battery and the intervention delay time has elapsed.
STARTING FAILURE	STARTING FAILURE 	BATTERY -Starting Motor	Always active	=	=	YES	QUICK	NOT	WITH STOP	The whole series of starting attempts is unable to start the engine.

DESCRIPTION OF FAULTS OR FUNCTIONS	INDICATION ON THE FRONT PANEL	MOTOR PUMP PROBE	INSTANT OF ACTIVATION (seconds)	INTERVENTION DELAY (seconds)	PROGRAMMED THRESHOLD (FACTORY SETTING)	STORES THE FUNCTION	DECELERATION	ENGINE COOLING	STOP	INTERVENTION OCCURS WHEN:
THE END OF WORK FUNCTION DUE TO FLOW SWITCH INTERVENTION	END OF WORK FLOW SWITCH 	FLOW SWITCH	When the pump protection active warning light  comes on	20	=	NOT	SLOW	YES	WITH STOP	There is no water flow and the intervention delay has elapsed.
AVAILABLE FAULT INPUT A1	A1	=	Always active	5	=	YES	SLOW	YES	WITH STOP	The input is negative (-) and the intervention delay has elapsed.
AVAILABLE FAULT INPUT A2	A2		With running engine							
FAILURE TO PRIME MAIN PUMP	FAILURE TO PRIME  (flashing)	PUMP PRIMING LEVEL PROBE	With running engine	240	=	YES	=	NOT	WITH STOP	The priming probe does not sense water presence and the intervention delay has elapsed.
FAILURE TO FILL PIPES	FAILURE TO FILL	ELECTRONIC PRESSURE SWITCH	With running engine	120	=	YES	SLOW	NOT	WITH STOP	The working pressure is not reached and the intervention delay has elapsed.
OVERSPEED	OVER-SPEEDS 	ALTERNATOR TERMINAL W	Always active	2	4000 RPM	YES	=	NOT	WITH STOP	The speed remains higher than the programmed threshold for the entire duration of the intervention delay.
INSUFFICIENT PUMP WATER PRESSURE	INSUFFICIENT WATER PRESSURE 	ELECTRONIC PRESSURE SWITCH	After detection of working pressure and in any case 600" after the pump started	5	=	YES	SLOW	YES	WITH STOP	The pump water pressure remains lower for the entire duration of the intervention delay.
PUMP WATER OVERPRESSURE	PUMP OVER-PRESSURE 									
ABNORMAL ACCELERATION	ABNORMAL ACCELERATION	ALTERNATOR TERMINAL W	With running engine	60	Allowed acceleration percentage 20%	YES	SLOW	NOT	WITH STOP	The speed remains higher than the programmed threshold for the entire duration of the intervention delay.
END OF WORK DUE TO UNDER-SPEED INTERVENTION	UNDERSPEED END OF WORK 		When the pump protection active warning light  comes on.	120	Allowed deceleration percentage 10%	NOT	SLOW	YES	WITH STOP	The speed drops below the programmed threshold and the working pressure remains constant for the entire duration of the intervention delay.
EMERGENCY STOP	EMERGENCY STOP 	EMERGENCY BUTTON	Always active	=	=	YES	=	NOT	WITH STOP	Emergency button is pressed.
ADJUSTMENT ERROR	ADJUSTMENT ERROR	ALTERNATOR TERMINAL W	With running engine	120	=	YES	=	NOT	WITH STOP	The rotation speed of the engine has not changed after 120 seconds.
PUMP WATER PRESSURE TRANSMITTER	TPA DISCONNECTED	ELECTRONIC PRESSURE SWITCH	ALWAYS ACTIVE	60	=	YES	SLOW	NOT	WITH STOP	The pressure transmitter circuit is disconnected.

WIRING DIAGRAM

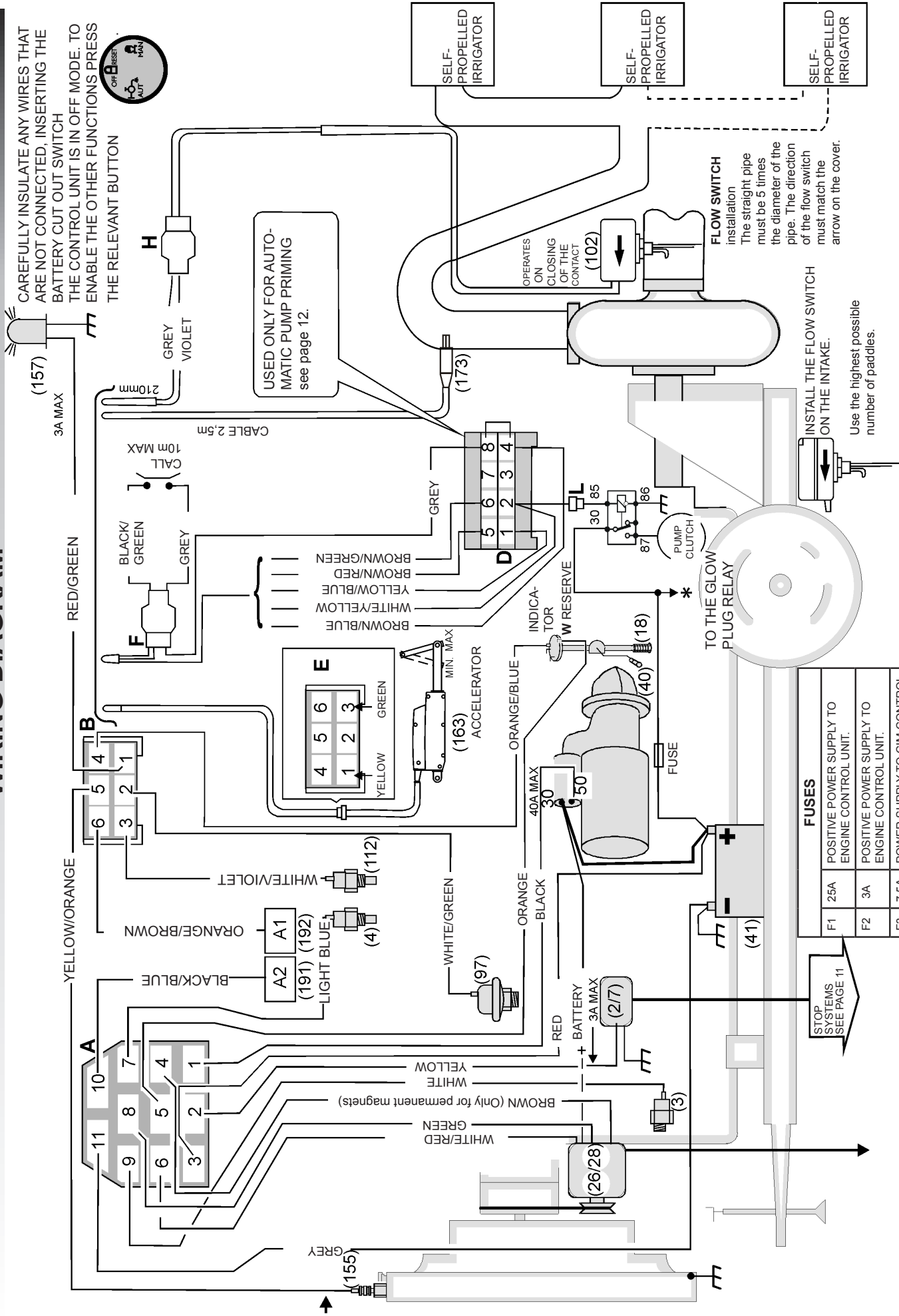

FUSES

F1	25A	POSITIVE POWER SUPPLY TO ENGINE CONTROL UNIT.
F2	3A	POSITIVE POWER SUPPLY TO ENGINE CONTROL UNIT.
F3	7.5A	POWER SUPPLY TO CIM CONTROL UNIT...

TO CHANGE THE FUSES REMOVE THE RELEVANT COVER OF THE CONTROL UNIT

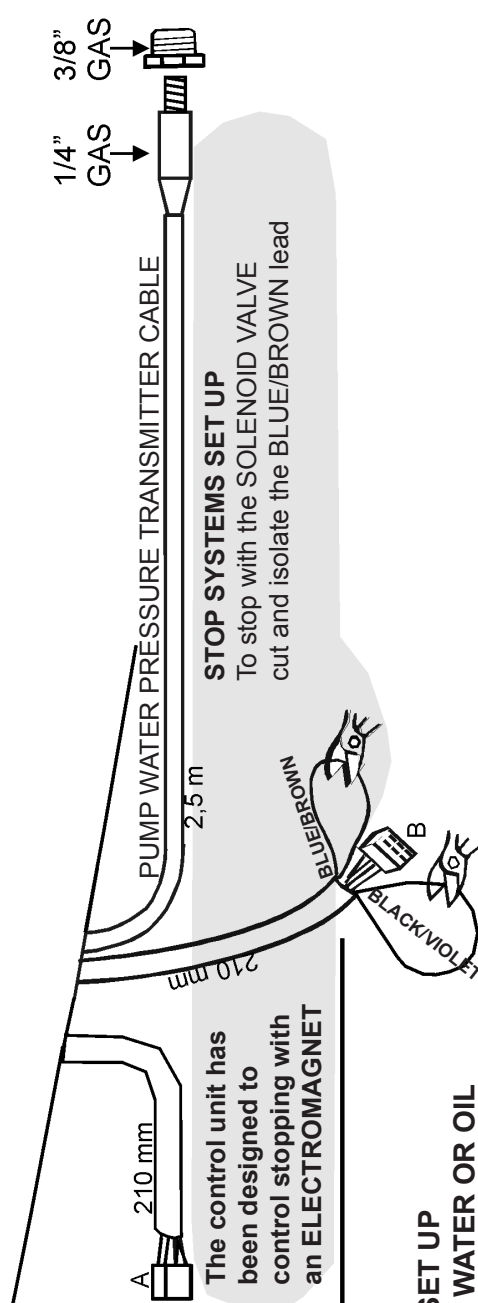
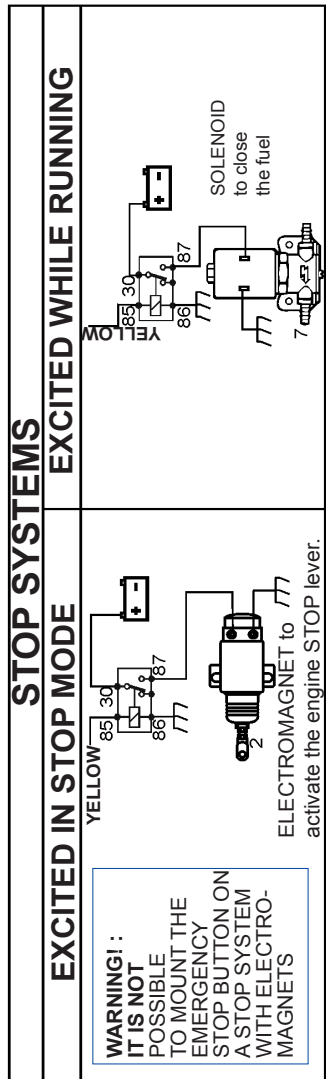
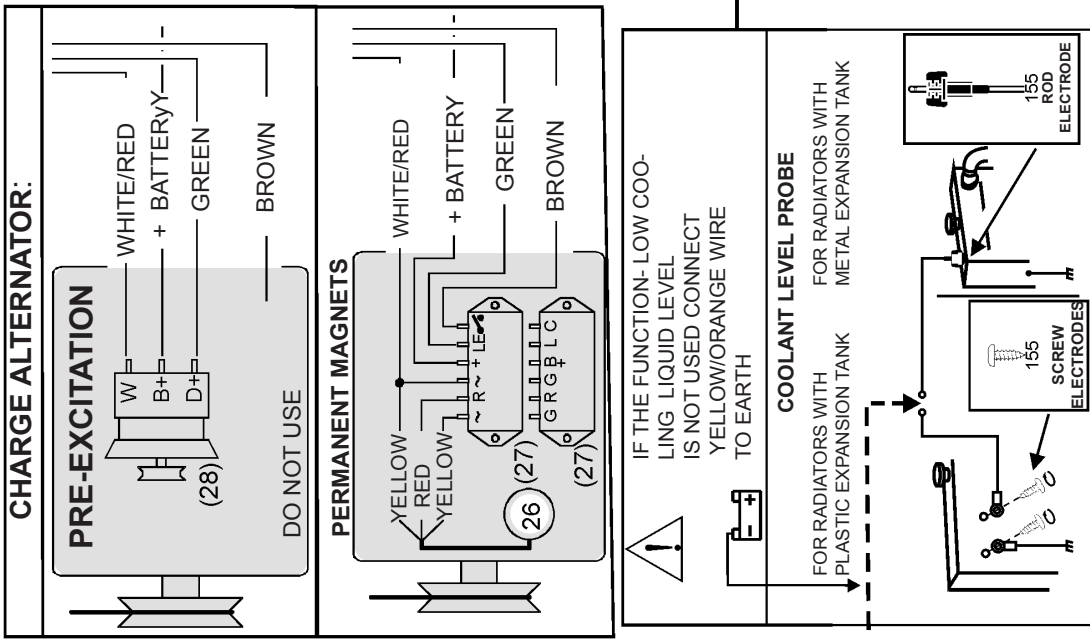

ELIMINATE THE BRIDGE WHEN CONNECTING THE EMERGENCY BUTTON

EMERGENCY STOP
 THIS CAN BE OBTAINED WITH A LATCHING BUTTON. ON RELEASING THE EMERGENCY BUTTON, STARTING OR MOTION OF THE ENGINE IS STOPPED. TO RESET, RELEASE THE BUTTON, PRESS

AND SELECT **POFF**

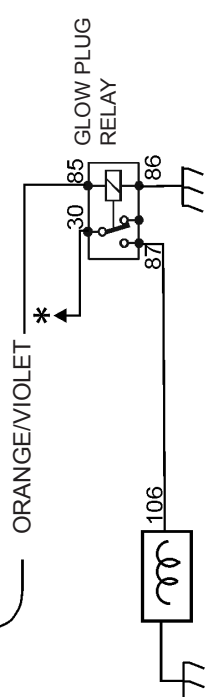

SETTING THE TACHOMETER see page 14

AUTOMATIC PUMP PRIMING CONNECTIONS

FEMALE CONNECTOR

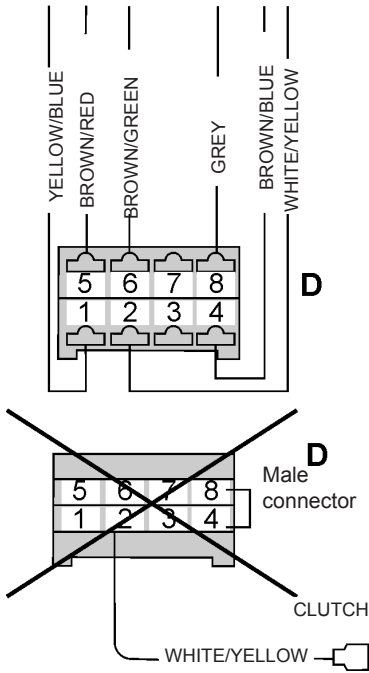

To connect PUMP PRIMING, remove the male connector, insert the connector with the wires brown/blue yellow/blue.

OPERATION AUTOMATIC PRIMING

The priming pump (P2) starts, when the water reaches the priming probe, the pump stops.

PRIMING FAILURE

The pump is stopped if the priming probe does not sense the presence of water within 240 sec..

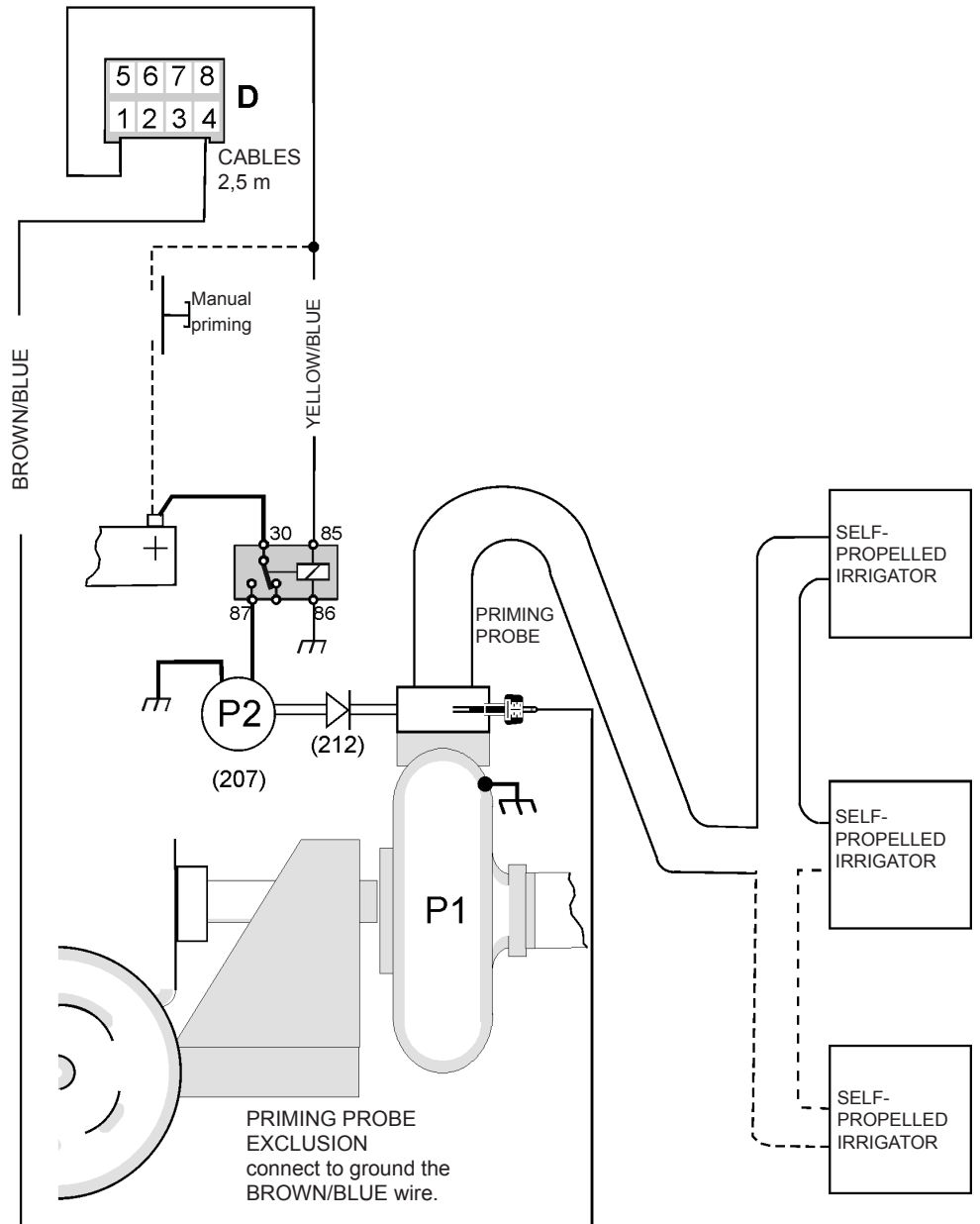

ACCESSORIES

ON REQUEST

- (2/7) ELECTROMAGNET OR ELECTRO-VALVE
- (3) OIL PRESSURE SWITCH
- (4) THERMOSTATIC SWITCH
- (18) FUEL FLOAT FOR INDICATOR AND RESERVE
- (97) OIL PRESSURE TRANSMITTER
- (102) WATER FLOW SWITCH
- (112) TEMPERATURE TRANSMITTER
- (155) RADIATOR LIQUID LEVEL PROBE
- (163) SPEED VARIATOR
- (173) PUMP WATER PRESSURE TRANSMITTER (SUPPLIED)

- (26) PERMANENT MAGNETS CHARGE ALTERNATOR
- (27) ALTERNATOR REGULATOR
- (28) PRE-EXCITATION CHARGE ALTERNATOR
- (40) STARTING MOTOR
- (41) BATTERY
- (106) GLOW PLUGS
- (157) VISUAL INDICATOR (GENERAL ALARM)
- (191) A1 AVAILABLE FOR PROTECTION PROBE
- (192) A2 AVAILABLE FOR PROTECTION PROBE
- (207) PRIMING PUMP
- (212) NON-RETURN PRIMING VALVE.

NOTICES

Only for starting and surveillance of the diesel motor pump and stops it if there are anomalies in the parts controlled by probes.

It has been designed to be installed also on the machine.



Warning:

adhere closely to the following advice

- Connect always following the wiring diagram shown on page 10-11.
- Each technical operation must take place on the motor pump unit with the engine stopped and with terminal 50 of the starter motor disconnected.
- Check that the line loading and the consumption of the connected equipment are compatible with the described technical characteristics.
- Install in such a way that there is always adequate heat disposal.
- Always install under other equipment which produces or spreads heat.
- Make sure that no copper conductor cuttings or other waste material fall inside the control unit.
- Never disconnect the battery terminals with the engine running.
- Never use a battery charger for the emergency start-up, this could damage the control unit.
- To protect the safety of persons and the equipment, before connecting an external battery charger, disconnect the electrical plant terminals from the battery poles.

THIS CONTROL UNIT IS NOT SUITABLE FOR OPERATING IN THE FOLLOWING CONDITIONS:

- Where the environmental temperature is outside the limits indicated in the Technical Data.
- Where the air pressure and temperature variations are so rapid as to produce exceptional condensation.
- Where there are high levels of pollution caused by dust, smoke, vapour, salts and corrosive or radioactive particles.
- Where there are high levels or heat from radiation caused by the sun, ovens or the like.
- Where attacks from mould or small animals are possible.
- Where there is the risk of fire or explosions.
- Where the control unit can receive strong vibrations or knocks.

ELECTROMAGNETIC COMPATIBILITY

This control unit functions correctly only if inserted in plants which conform with the CE marking standards; it meets the exemption requirements of the standard EN61326-1 but it cannot be excluded that malfunctions could occur in extreme cases due to particular situations.

The installer has the task of checking that the disturbance levels are within the requirements of the standards.

CONDUCTION AND MAINTENANCE

The following maintenance operations should be performed every week:

- check that the indicators function;
- check the batteries;
- check that the conductors are tight, check the condition of the terminals.

UNLESS WE MAKE A WRITTEN DECLARATION STATING THE CONTRARY, THIS CONTROL UNIT IS NOT SUITABLE FOR USE AS A CRITICAL COMPONENT IN EQUIPMENT OR PLANTS RESPONSIBLE FOR KEEPING PERSONS OR OTHER LIVING BEINGS ALIVE.

YOUR ELECTRICAL TECHNICIAN CAN ASK US ANYTHING ABOUT THIS CONTROL UNIT BY TELEPHONING ONE OF OUR TECHNICIANS

USER PROGRAMMING

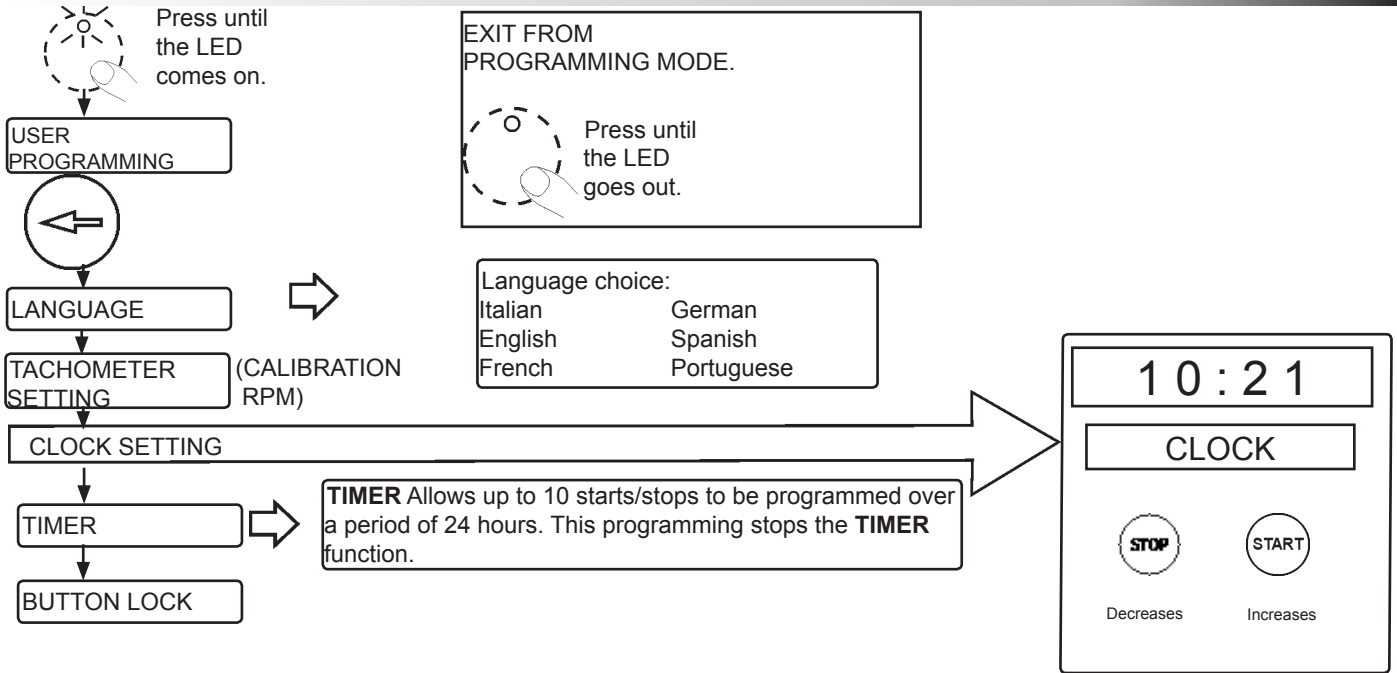

LANGUAGE CHOICE. The language set up is ITALIAN; the languages that can be selected are: ENGLISH - FRENCH - GERMAN - SPANISH - PORTUGUESE.



TACHOMETER ADJUSTMENT WITH CHARGING ALTERNATOR FREQUENCY W.

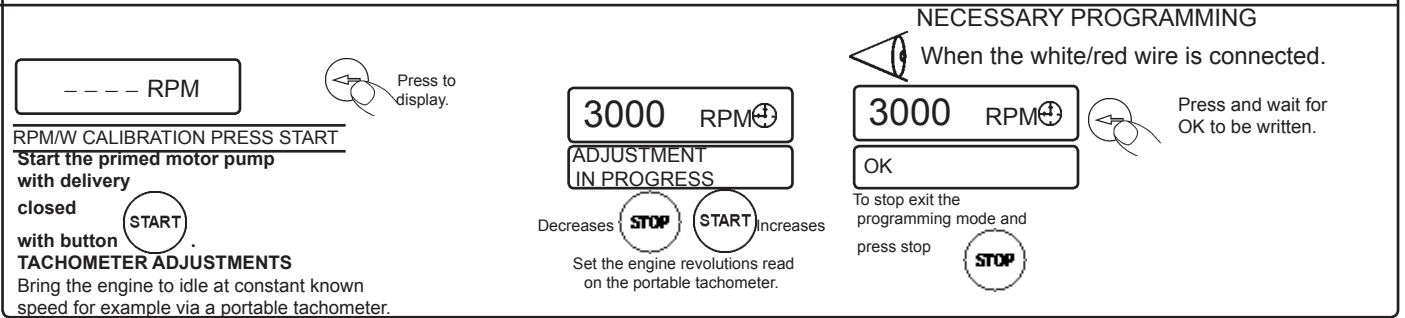

CLOCK allows up to 10 STARTS/STOPS to be programmed over a period of 24 hours. Carry out setting operations with the engine stopped. The control unit accepts only complete programming settings: START 1 → STOP 1
START 2 → STOP 2 and so on

If a start is programmed, but a stop is not programmed, **ERROR** is written on the display. While running with the engine started by clock, indicator stays on. During stopping by clock, indicator comes on and stays on until the next start.

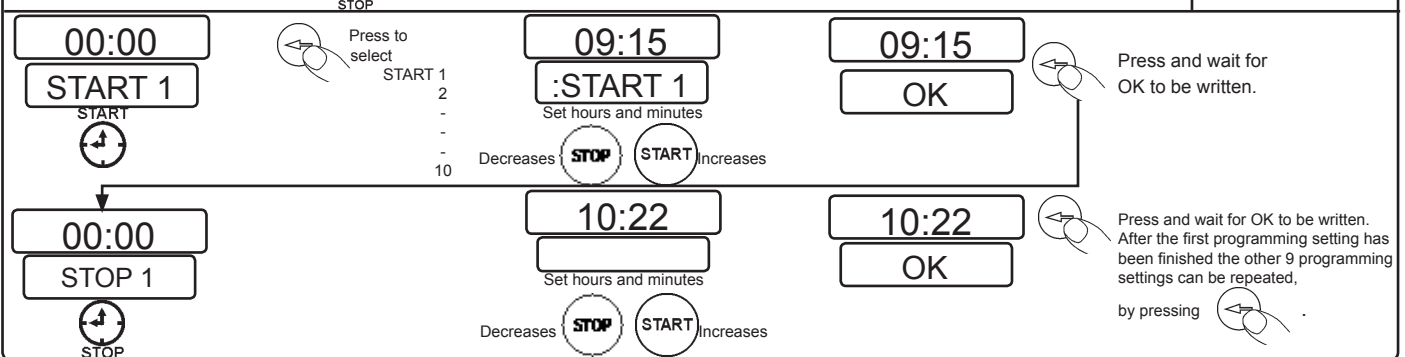

BUTTON LOCK. With the push-button panel locked, buttons remain active.

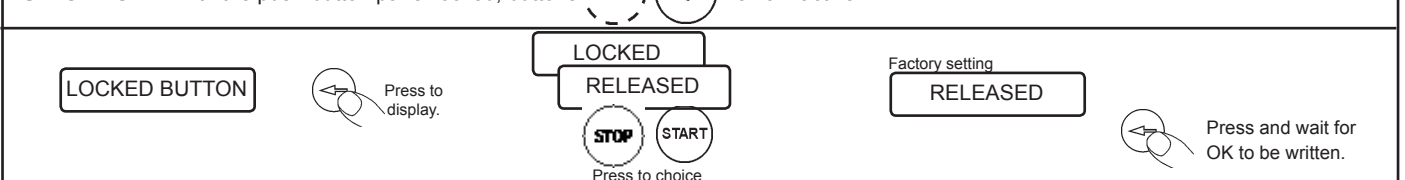

DIMENSIONS

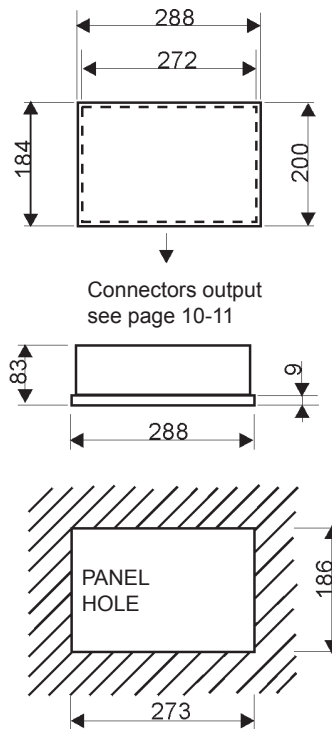

TECHNICAL DATA

Battery power supply	12 Vdc 24 Vdc
Supply voltage	8 ÷ 32V
Consumption in standby	3.5mA at 12V
	2.5mA at 24V
Consumption with engine stationary	250mA at 12V
	150mA at 24V
Max. Consumption	850mA at 12V
	550mA at 24V
Max load of the output:	
• (stopping) yellow	3A
• (starting motor) black	40A
• (general alarm) red/green	3A
• (auxiliary) brown	3A
• priming pump yellow/blue	3A
• pump clutch white/yellow	3A
Temperature range	-10 ÷ +60 °C
Hour-meter	4 digits
Engine oil pressure gauge	0 ÷ 9 bar
Pump water pressure transmitter:	
• allowed max. pressure	21 bar
Engine water and oil thermometers	+20 ÷ +145°C
Tachometer	4000 rpm
Timer	1' ÷ 24 h
Serial communication parameters	9600 baud, 8 bit data, 1 bit stop, even parity
Rechargeable batteries	2x1,2V type AAA
Installation conditions	for external use
Degree of protection box/connector	IP54/IP20
Control unit weight	2,2 kg
Weight with control unit mounted on the support	4,6 kg

ORDERING DATA

Type CIM-131

Codice 00211101

ACCESSORIES SUPPLIED

- PRE-WIRED CONNECTOR CIM-130/1/6/7

CODE 70804397

- PUMP WATER PRESSURE TRANSMITTER TYPE TPA-200
- NIPPLE F1/4" GAS -M3/8"GAS
- NUTS KIT

" 70500255
" 70190241
" 40179906

ACCESSORIES ON REQUEST

Type

Code

- Support KIT CRU-CIM 40493383
- Speed variator VAR-140 12V 00571543
- Flow switch FAP-100 00500312



BASE FITTING